

Global Fisher Pre-Rinse - WALL -

PROUD TO BE AUSSIE MADE

Hello,
When you buy one of our products you can rest easy knowing that you are buying a product that has an established track record in Quality & Performance and is backed up with readily available spare parts Australia wide.

Our Brands & Company Reputation mean everything to us & we detest having any issues, so we work hard to avoid any occurring, this equals a 99.5% success rate across the board on all our products.

Mark McQueen
Managing Director



25mm **Bench Hole size**

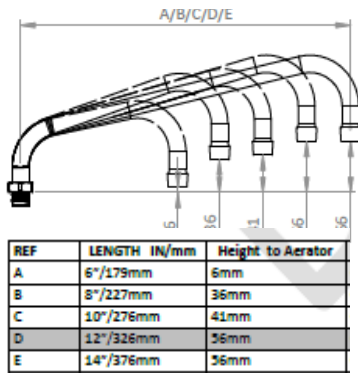

- ✓ 'Global Tapware P/L' has a proven track record, since 2010, of Manufacturing High Quality Products here in Australia. - visit us on our Web site -
- ✓ 'Global Fisher' Pre-Rinses are made in our Brisbane, Qld, Factory. They are not made in the USA as those units are not 'Watermarked' and do not comply to Australian Standards, that is why we invested in making components here in Australia to make them comply.
- ✓ 'Global Fisher' Pre-Rinses, as from the 1/8/20, are now made fully from 304 STAINLESS STEEL components.
- ✓ 'Global Fisher' Pre-Rinses work for years & years. If treated properly you could get 5-10 yrs of use before parts wear & require replacing.
- ✓ 'Global Fisher' Quality Pre-Rinses & Accessories / Spare Parts are available via all Plumbing & Catering Retailers throughout Australia.
- ✓ 'Global Fisher' has a 36-month on-site warranty for genuine claims, we do not cover installation claims.
- ✓ 'Global Fisher' Pre-Rinses are all Assembled & Pressure Tested before packed in our Brisbane factory. - this has eliminated bad install complaints by 99.5%.
- ✓ We Laser Etch our products, in our factory, with our Brand Name or Logo - No stickers. We do this, so you know where to source spare parts from in the future, unlike some of our competing imported products that show no branding.

- ✓ Suitable for R.O. Applications.
- ✓ Suitable for TOUGH Environments.
- ✓ Commercial Rated.
- ✓ Best on market

Standard Model (no Pot Filler)

Pt. No. **GF162100** \$ _____ + GST

Standard Model w/ 12" Pot Filler

Pt. No. **GF162512** \$ _____ + GST

Note: - Other Spout lengths available at same pricing. Change last 2 digits to the size you require i.e.- 6" = 06 or 14" = 14

Details are accurate at the time of printing. Dimensions are indicative only and may change without notice, seek confirmation before relying on any dimensions shown.

BROCH. -GF162-V1-2020